

# Vixen®

## Instruction Manual for PF-L II Polar Alignment Scope



## Allgemeine Warnhinweise

Read the safety instructions and the operating instructions carefully before using the appliance.

Keep these operating instructions in a safe place for future reference. If the appliance is sold or passed on, the operating instructions must be passed on to any subsequent owner/user of the product.

Respect the privacy of those around you - do not look into flats with this device, for example!

## DANGER of bodily injury

Never look directly at or near the sun with this unit. There is a DANGER OF BLINDNESS!

Children may only use the unit under supervision. Keep packaging materials (plastic bags, rubber bands, etc.) away from children!

There is a DANGER OF CHOKING!

Not suitable for children under 3 years!

## RISK OF FIRE

Do not expose the unit - especially the lenses - to direct sunlight! The light bundling could cause fires.

Do not expose the unit to temperatures above 60 °C!

## Warranty & Service

The regular warranty period is 2 years and starts on the day of purchase. The complete warranty conditions as well as information on warranty extensions and services can be found at:



[www.bresser.de/warranty\\_terms](http://www.bresser.de/warranty_terms)

## EC DECLARATION OF CONFORMITY



Hereby, Bresser GmbH declares that the equipment type with part number: X000327 is in compliance with Directive: 2014/53/EU.

The full text of the EU declaration of conformity is available at the following internet address:

[www.bresser.de/download/X000327/CE/X000327\\_CE.pdf](http://www.bresser.de/download/X000327/CE/X000327_CE.pdf)

## UKCA DECLARATION OF CONFORMITY



Bresser UK Ltd. has issued a „Declaration of Conformity“ in accordance with applicable guidelines and corresponding standards.

The full text of the UKCA declaration of conformity is available at the following internet address:

[www.bresser.de/download/X000327/UKCA/X000327\\_UKCA.pdf](http://www.bresser.de/download/X000327/UKCA/X000327_UKCA.pdf)

Bresser UK Ltd. • Suite 3G, Eden House, Enterprise Way, Edenbridge, Kent TN8 6HF, Great Britain

## Entsorgung



Dispose of the packaging materials properly, according to their type, such as paper or cardboard. Contact your local waste-disposal service or environmental authority for information on the proper disposal.



Do not dispose of electronic devices in the household garbage! As per the Directive 2002/96/EC of the European Parliament on waste electrical and electronic equipment and its adaptation into German law, used electronic devices must be collected separately and recycled in an environmentally friendly manner.



In accordance with the regulations concerning batteries and rechargeable batteries, disposing of them in the normal household waste is explicitly forbidden. Please make sure to dispose of your used batteries as required by law — at a local collection point or in the retail market. Disposal in domestic waste violates the Battery Directive. Batteries that contain toxins are marked with a sign and a chemical symbol.



<sup>1</sup> battery contains cadmium

<sup>2</sup> battery contains mercury

<sup>3</sup> battery contains lead

## Polar Alignment Scope

If your intention is to take long exposure astrophotography, you must accurately align the polar axis (R.A) of the mount to the celestial pole. This requires the use of a polar alignment scope. The polar alignment scope can align the polar axis of the mount as accurately as 3 arc minutes or less.

## Components guide

### ON/OFF the Dark Field Illuminator

There is a push switch on the top of the brightness adjusting dial of the polar alignment scope. Pushing the switch will illuminate the polar alignment reticle in red light. The red light becomes dimmer gradually after a certain interval of illumination (about one or two minutes) and turns off automatically.



### Adjusting the Brightness of the Dark Field Illuminator

The brightness of the red light for the polar alignment reticle can be varied in 8 steps by turning the brightness adjusting dial of the polar alignment scope.



You can focus on the polar alignment reticle by turning the eyepiece of the polar alignment scope. While holding the body of the polar alignment scope on one hand, turn the eyepiece part with the other hand.



## Replacing the Battery

**1** While holding the brightness adjusting dial by hand, remove the battery cover (the switch for illuminator) on the top of the brightness adjusting dial by turning it counterclockwise.

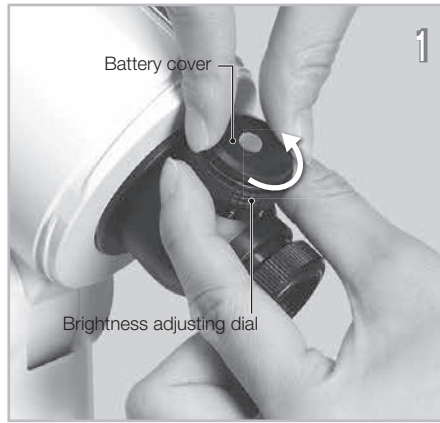

**2** Turn the battery compartment on the polar alignment scope downward as shown in the figure so that the old battery can fall out of from the battery compartment.



**3** Turn the battery compartment upward and insert a fresh battery in the battery compartment. The bottom of the battery compartment is the plus side.



**4** Replace the battery cover in place. Be sure to check if the dark field illuminator is lit by turning on the switch.

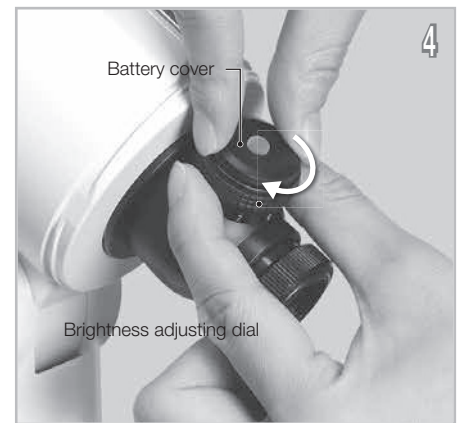

## Reticle of the Polar Alignment Scope

Star Names	Constellations
Polaris	Little Bear
$\delta$ UMi	Little Bear
51 Cep	Cepheus
$\sigma$ Oct	Octans
$\tau$ Oct	Octans
$\chi$ Oct	Octans
$\alpha$ Eri	Eridanus

Numbers

15 the year 2015

40 the year 2040

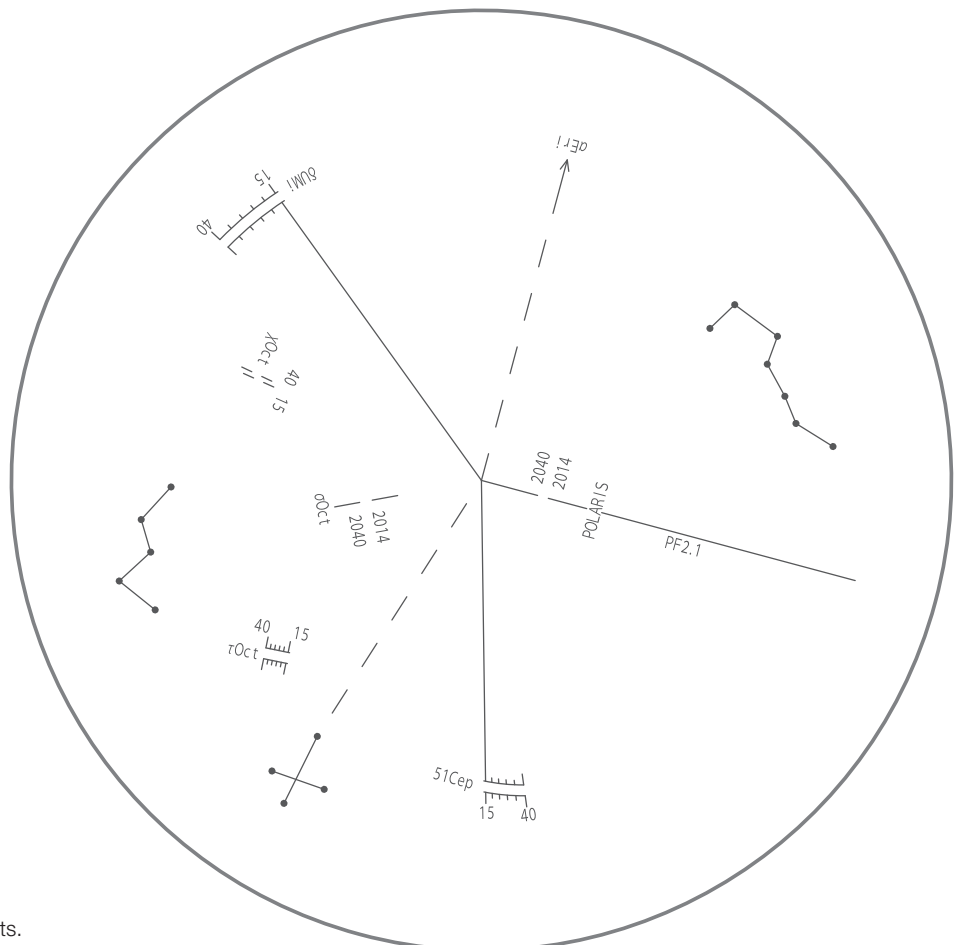

The position scales on the reticle are 5-year increments.

## Polar Alignment in the Northern Hemisphere

The polar axis of the AP equatorial mount is aligned to the North Celestial Pole in the northern hemisphere. The polar alignment scope utilizes 3 stars of Polaris, Delta UMi and 51 Cep near the North Pole. Positions of the above stars are plotted on the reticle of the polar alignment scope. To locate the N.C.P, you simply match the scale position on the reticle with the designated 3 stars seen in the polar alignment scope. Also, the patterns of the Big Dipper and Cassiopeia are engraved on the reticle for use as a guidepost for the North Pole.

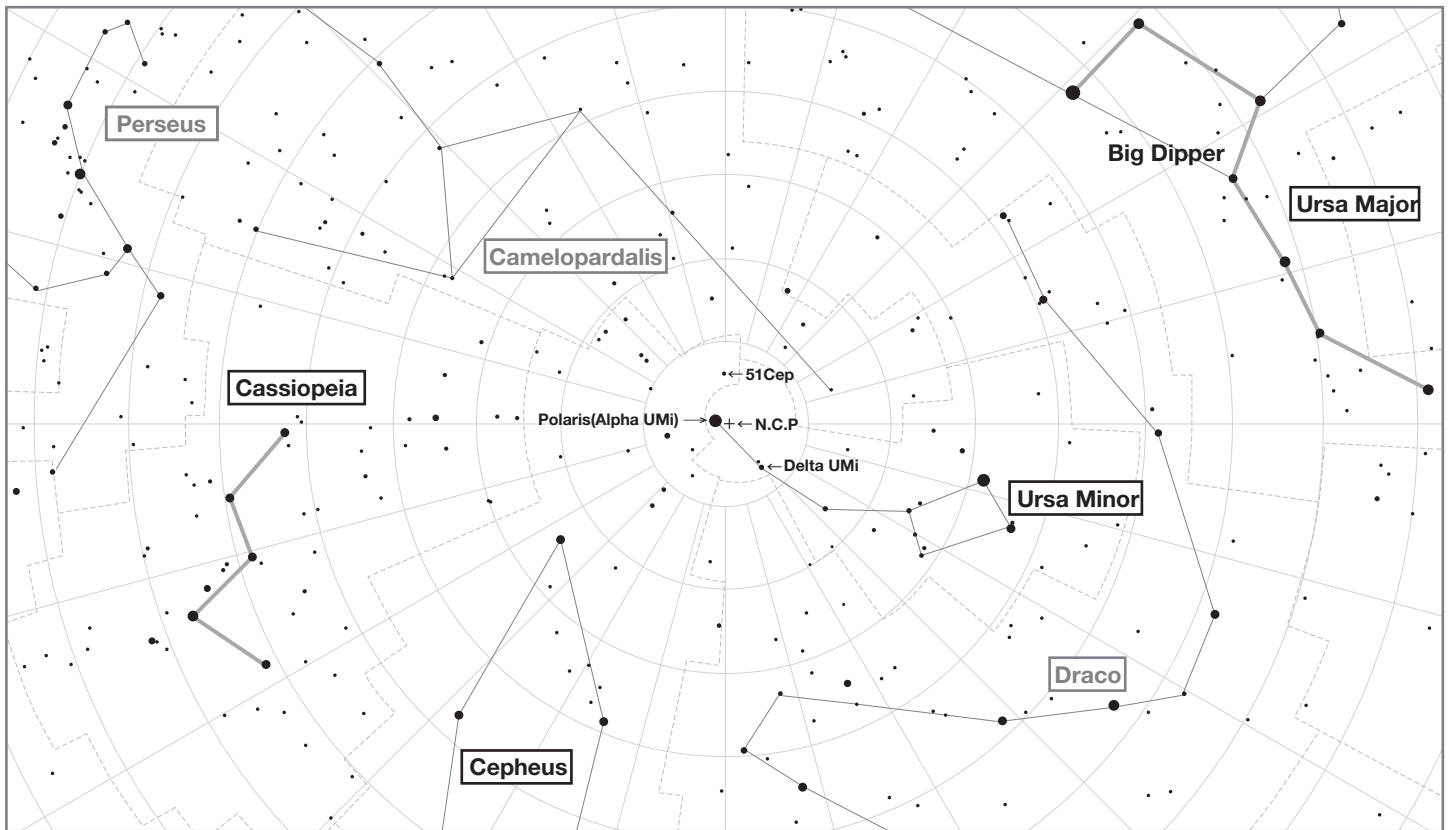

**1** Check your observing site with a compass, a GPS system or a map in advance to confirm that Polaris, the Big Dipper and Cassiopeia can be seen from your observing location on the date of observation.

**2** Set up the mount on flat and hard ground where you can see Polaris in the sky. Take off the polar axis cap. Point the polar axis of the mount in the direction of north as shown in the figure. Adjust the tripod legs so that the tripod is as level as possible.

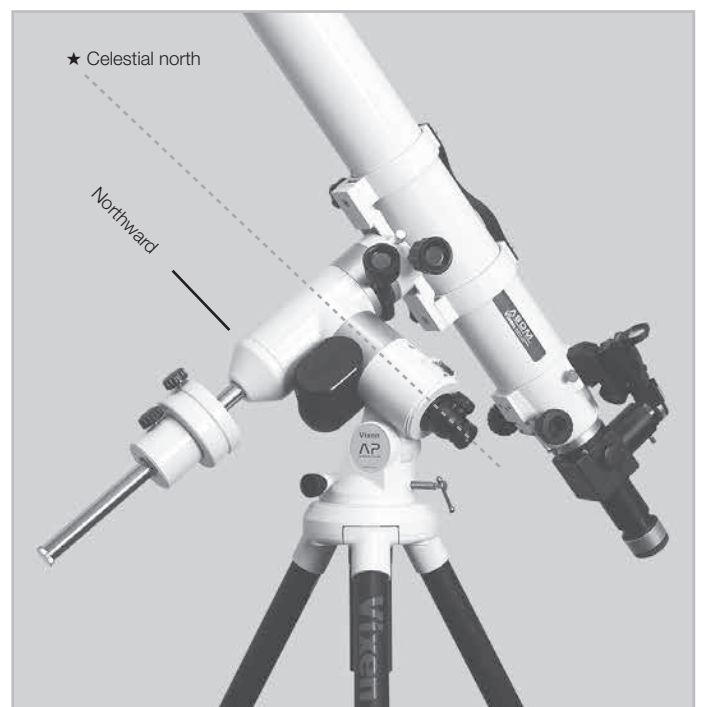
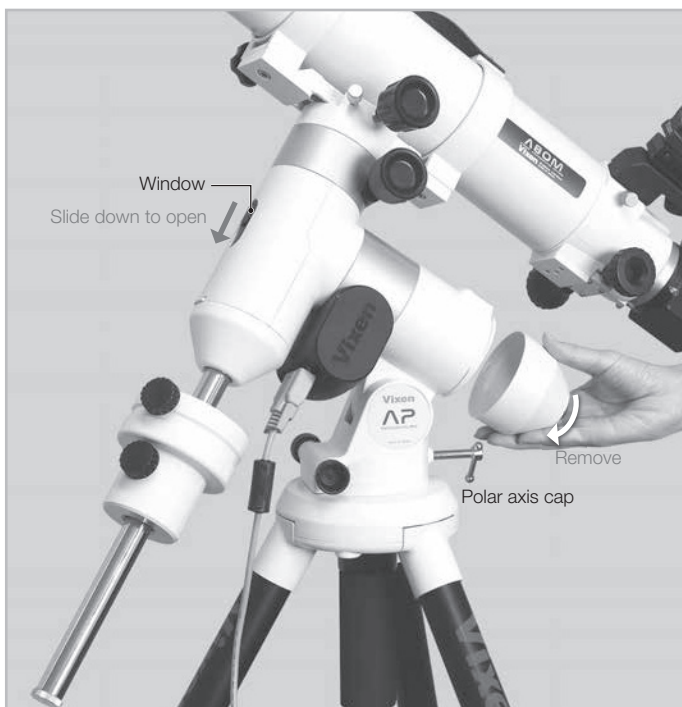

3 Open the round window on the declination body by sliding down the shutter of the window. While looking into the polar alignment scope, turn the polar alignment scope body so that the engraved Big Dipper (or Cassiopeia) on the reticle matches the Big Dipper (or Cassiopeia) in the real sky.

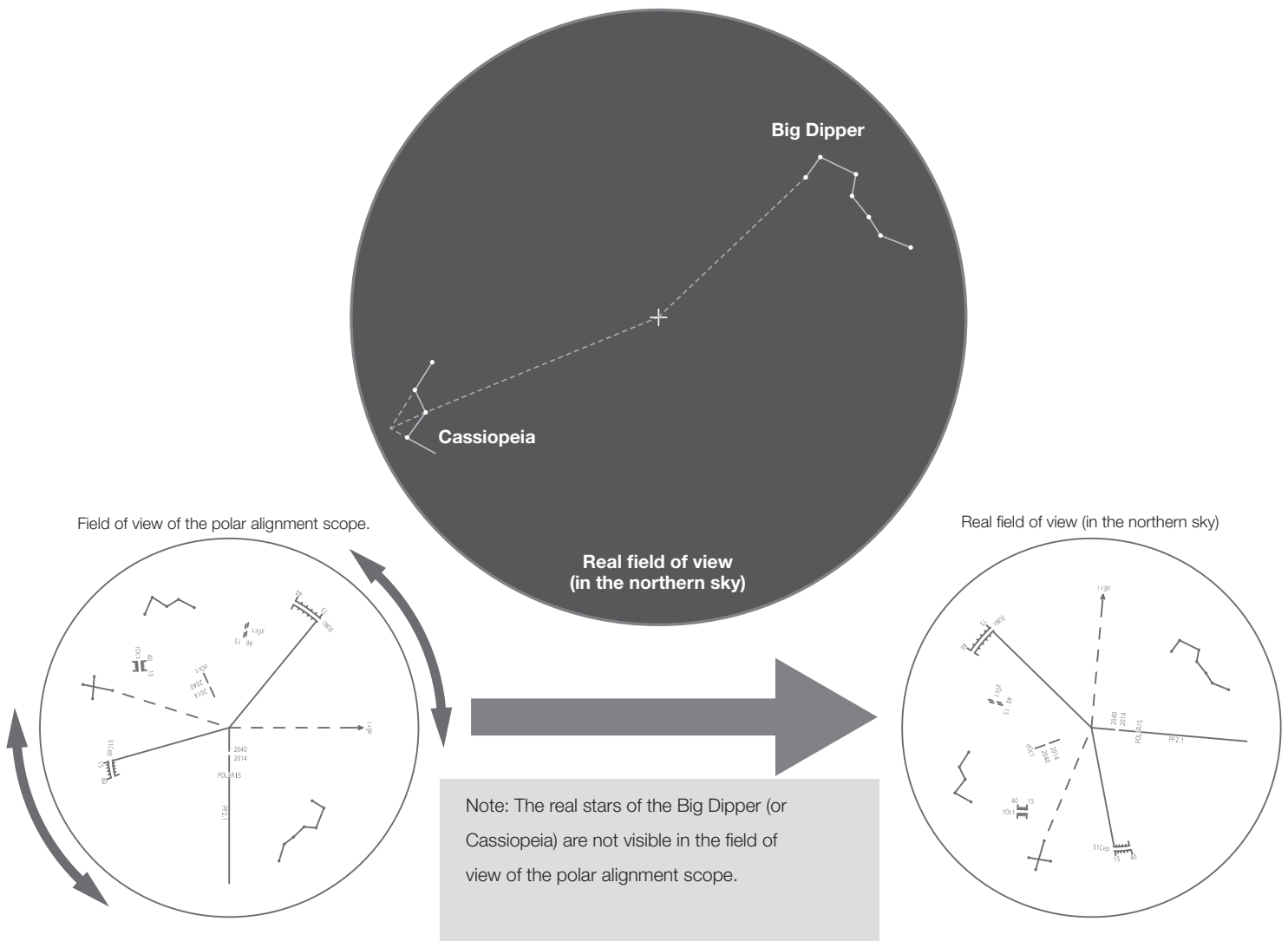
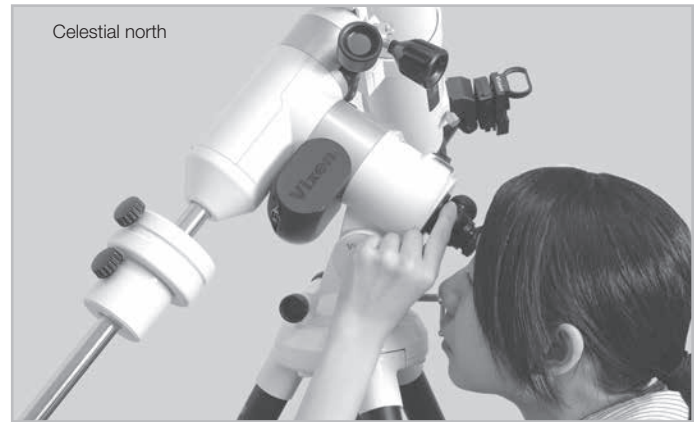
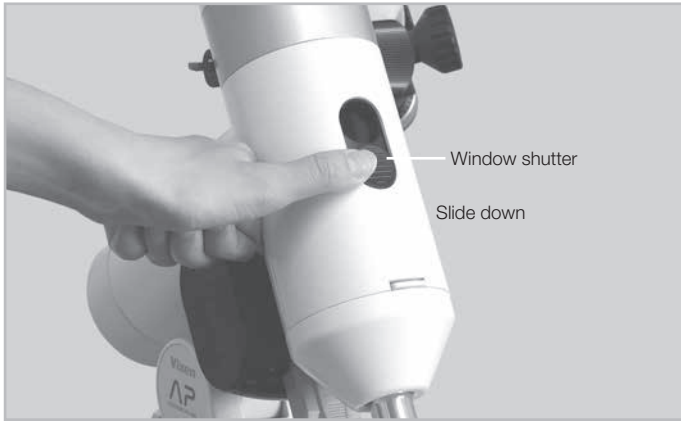

The patterns of the Big Dipper and Cassiopeia on the reticle are positioned to correspond to the real sky. They are used as a guidepost to know the turning direction of the polar alignment scope's reticle. The locations of the Big Dipper and Cassiopeia on the reticle have no relation to the location of Polaris, Delta UMi and 51 Cep on the reticle.

4 While looking into the eyepiece of the polar alignment scope, adjust the direction of the mount by turning the altitude adjustment bolt and azimuth adjustment knobs so that Polaris comes as close as possible to the designated position on the reticle.

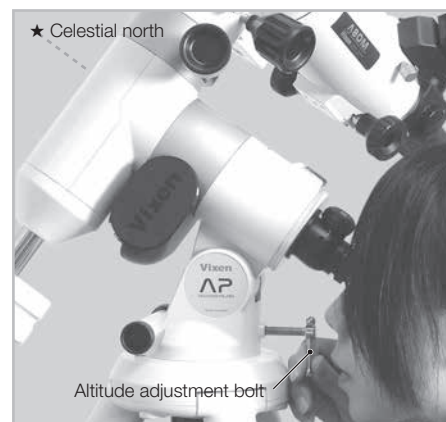

Set Polaris to the gap between the two segments of the lines marked 2014 and 2040 adjacent to a mark "POLARIS" as shown in the figure.

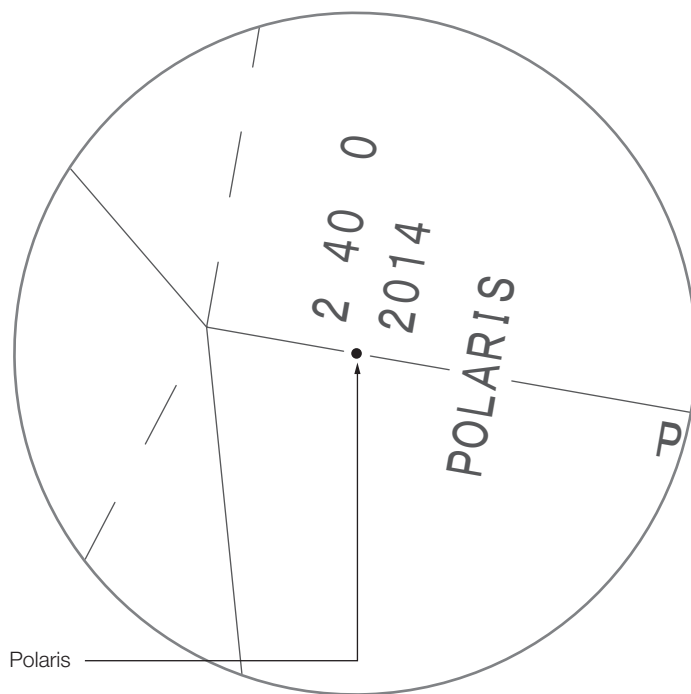

5 As Polaris shifts to the designated position on the reticle, both Delta UMi and 51 Cep come close to their own designated position scales respectively. While looking into the eyepiece of the polar alignment scope, turn the polar alignment scope body so that each of the position scale for Delta UMi and 51 Cep come to the closest to actual Delta UMi and 51 Cep respectively.

The numbers 15 and 40 on the position scales for Delta UMi and 51 Cep show the years 2014 and 2040 respectively.

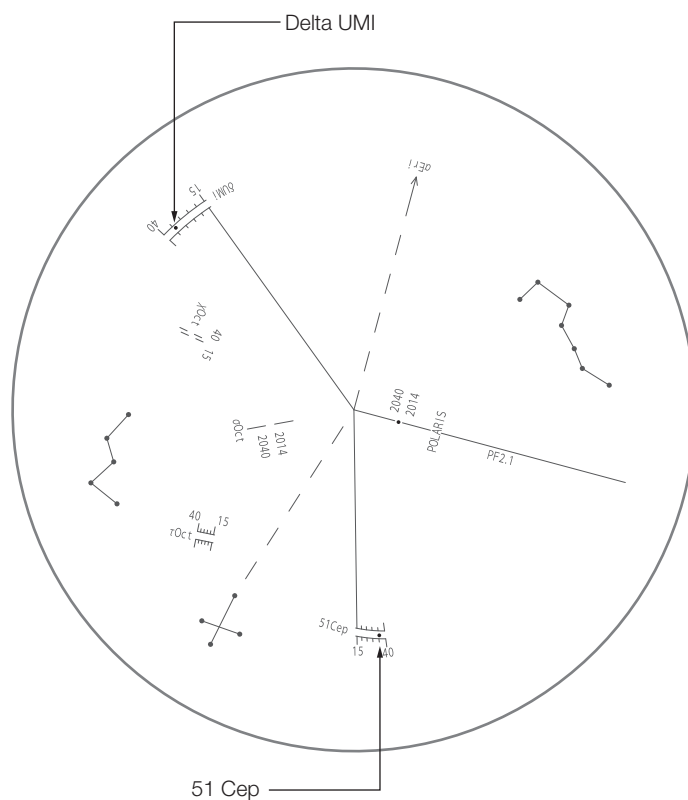

Polaris is out of place from the designated position. This is part of the process.

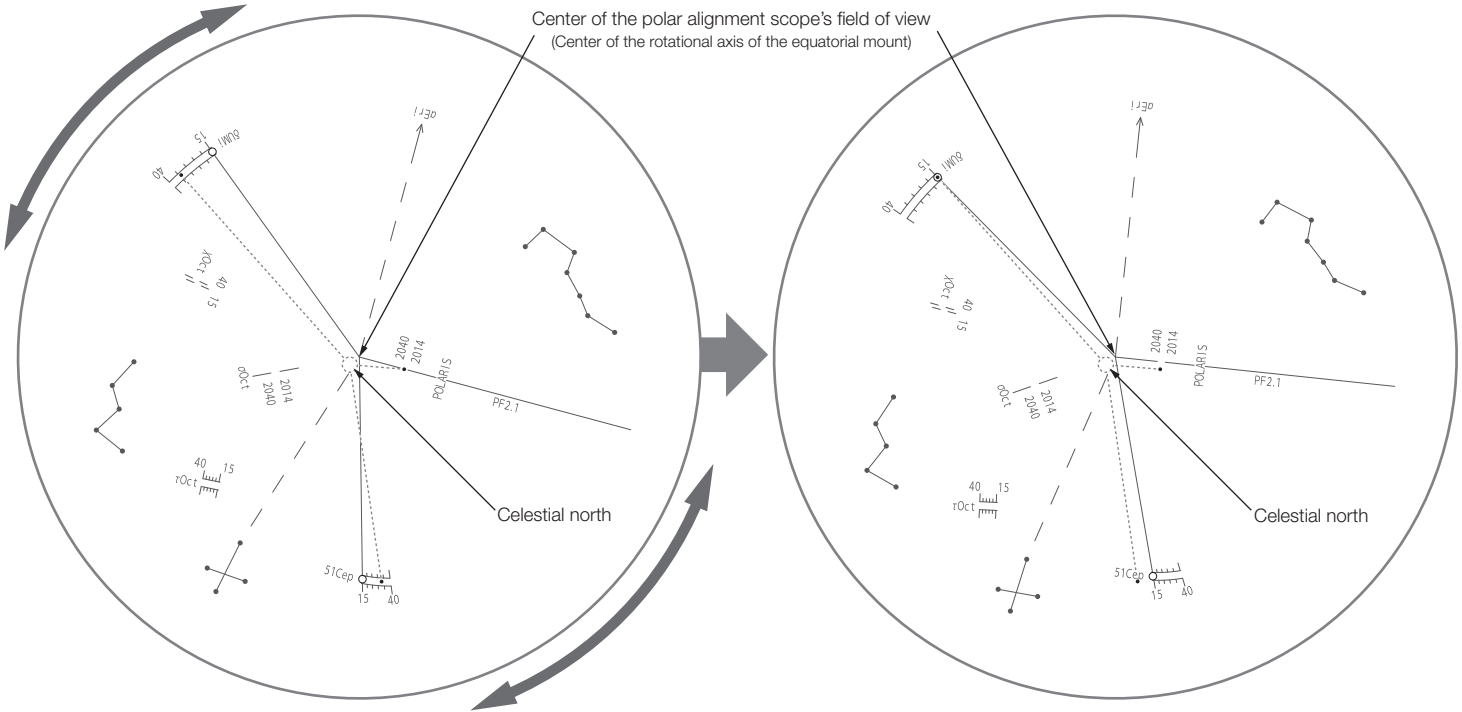

Since there is no mark that points at the North Celestial Pole, you need to match the polar axis of your AP equatorial mount with the N.C.P using the conspicuous polar star and two stars in the same area of the sky. This is called polar alignment.

Your goal is to set Polaris to the edge of the line on the side of 2014, and both Delta UMi and 51 Cep are to be set to the middle of the curved lines of the position scale at the protruded edge on the side of 15 respectively. (In case of the year 2014)

Turn the polar alignment scope body so that Delta UMi comes near to the location of the year 2014 on the scale. And then, Polaris will get out of position from the gap between the lines.

Adjust the red light illumination to be dimmer if the reticle is too bright to see the 4th magnitude Delta UMi.

If the 5th magnitude 51 Cep is hard to see in the polar alignment scope's field of view, at least be sure to set Delta UMi to the position scale on the reticle.

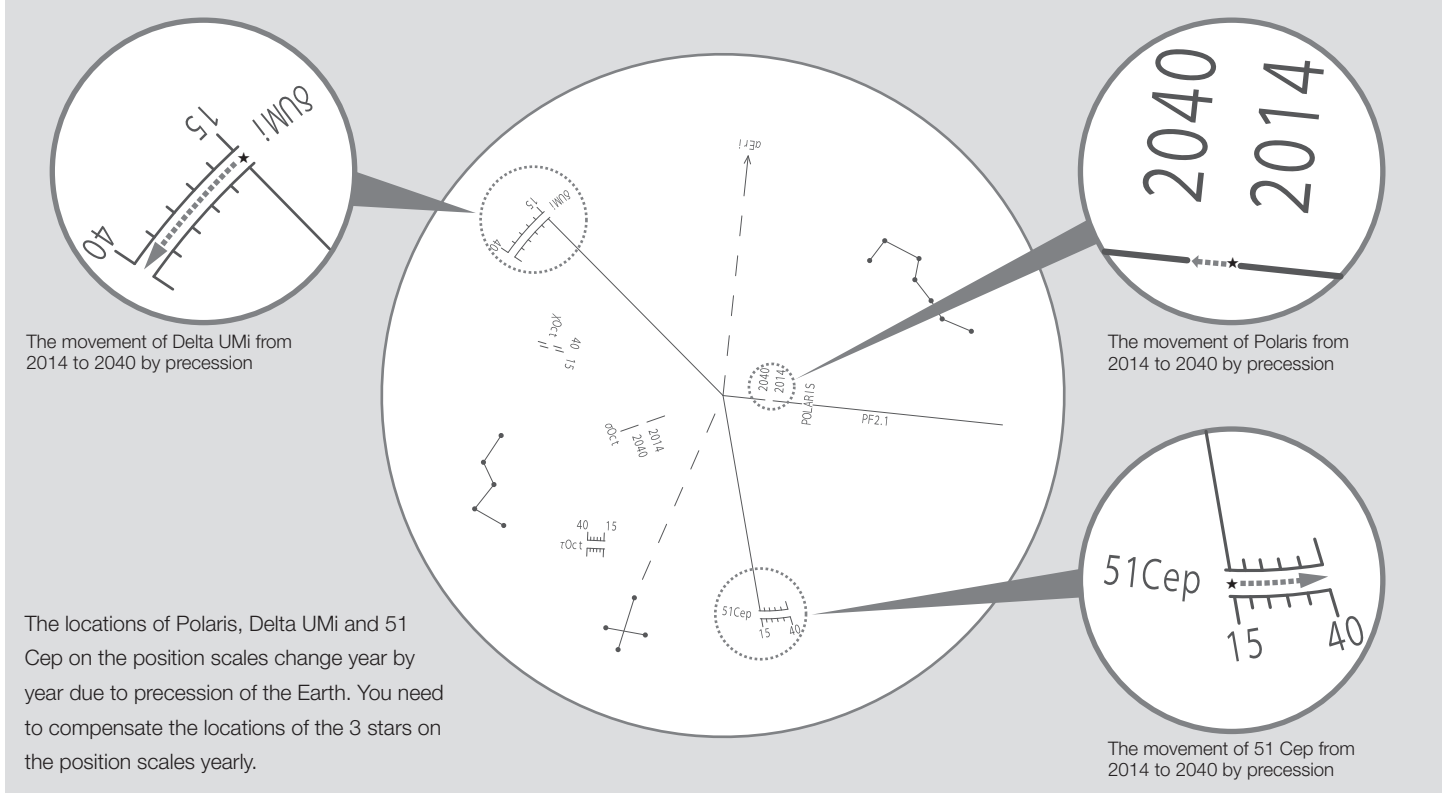

The movement of Delta UMi from 2014 to 2040 by precession

The movement of Polaris from 2014 to 2040 by precession

The locations of Polaris, Delta UMi and 51 Cep on the position scales change year by year due to precession of the Earth. You need to compensate the locations of the 3 stars on the position scales yearly.

The movement of 51 Cep from 2014 to 2040 by precession



6 While looking into the eyepiece of the polar alignment scope, turn the altitude adjustment bolt and azimuth adjustment knobs so that Polaris comes to the gap between the two segments of the lines marked 2014 and 2040.

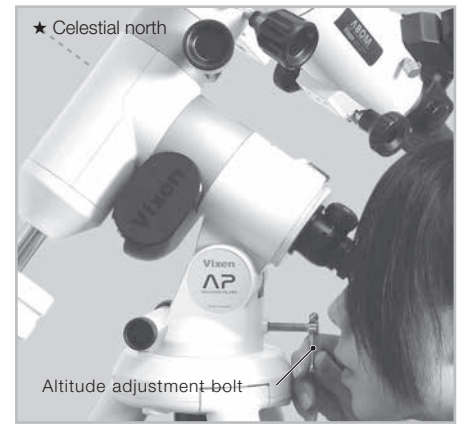

Correcting the position of Polaris with the altitude adjustment bolt and azimuth adjustment knobs  
 Correcting the position of Delta UMi and 51 Cep with a rotation of the polar alignment scope

Set Polaris to an approximate position that is corresponding to the year of your observation.

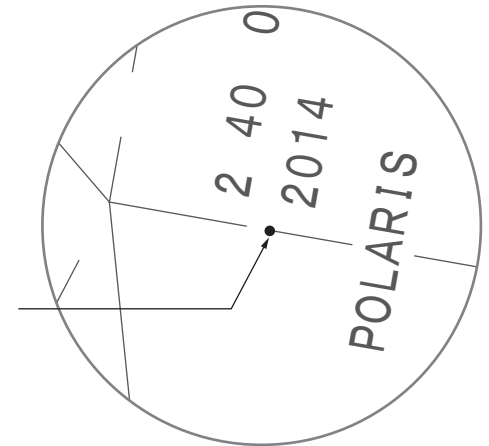

7 Repeat the procedures 11 and 12 until Polaris, Delta UMi and 51 Cep come to the proper locations on the designated position scales respectively. Tighten the azimuth adjustment knobs at both sides to finish the polar alignment.

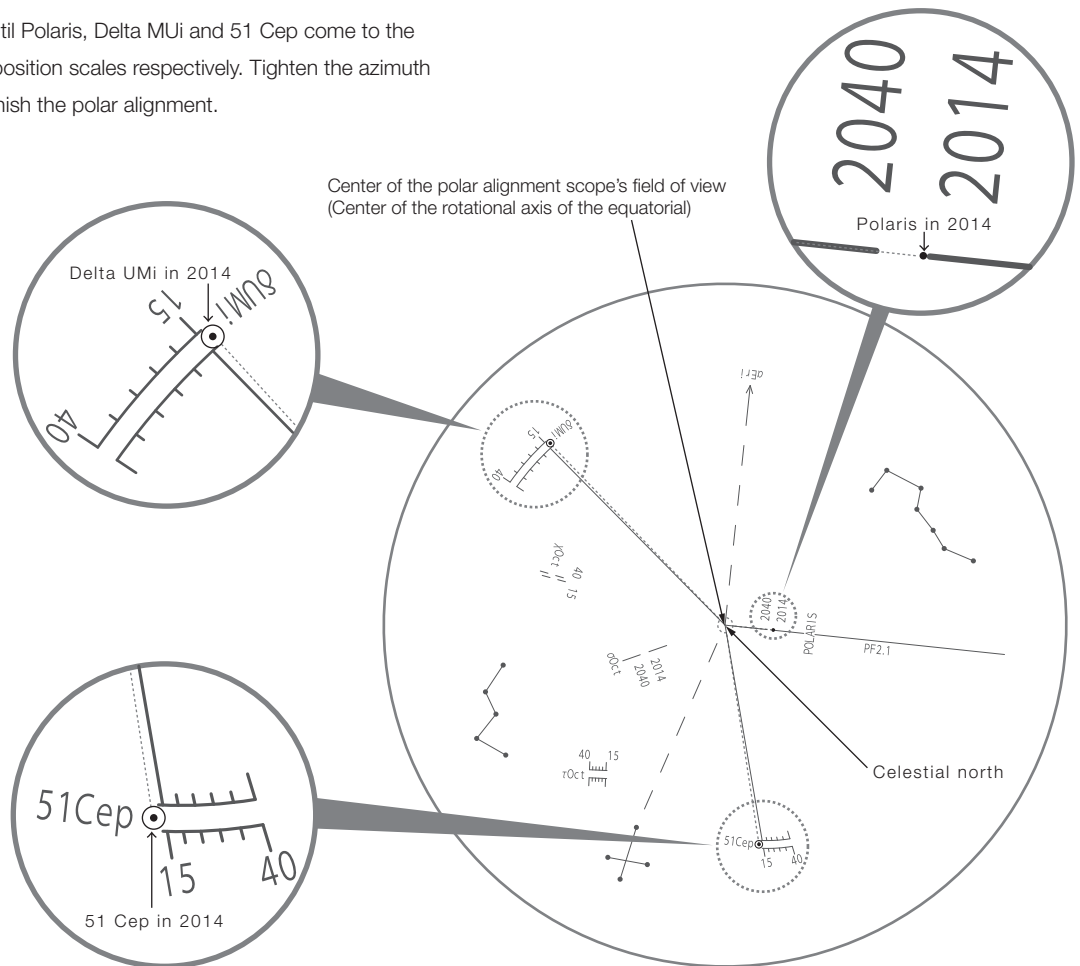

As an illustration here, Polaris is set to the edge of the line on the side of 2014, and both Delta UMi and 51 Cep are set to the middle of the curved lines of the position scale at the protruded edge on the side of 15 respectively. (In case of the year 2014)

## Polar Alignment in the Southern Hemisphere

The polar axis of the AP equatorial mount is aligned to the South Celestial Pole in the southern hemisphere. The polar alignment scope utilizes 3 stars of Sigma Octantis, Tau Octantis and Chi Octantis near the South Pole. Positions of these stars are plotted on the reticle of the polar alignment scope. To locate the S.C.P, you simply match each of the position scale on the reticle with the designated 3 stars caught by the polar alignment scope. Also, the pattern of the Southern Cross and Alpha Eridani are engraved on the reticle for use as a guidepost for the South Pole.

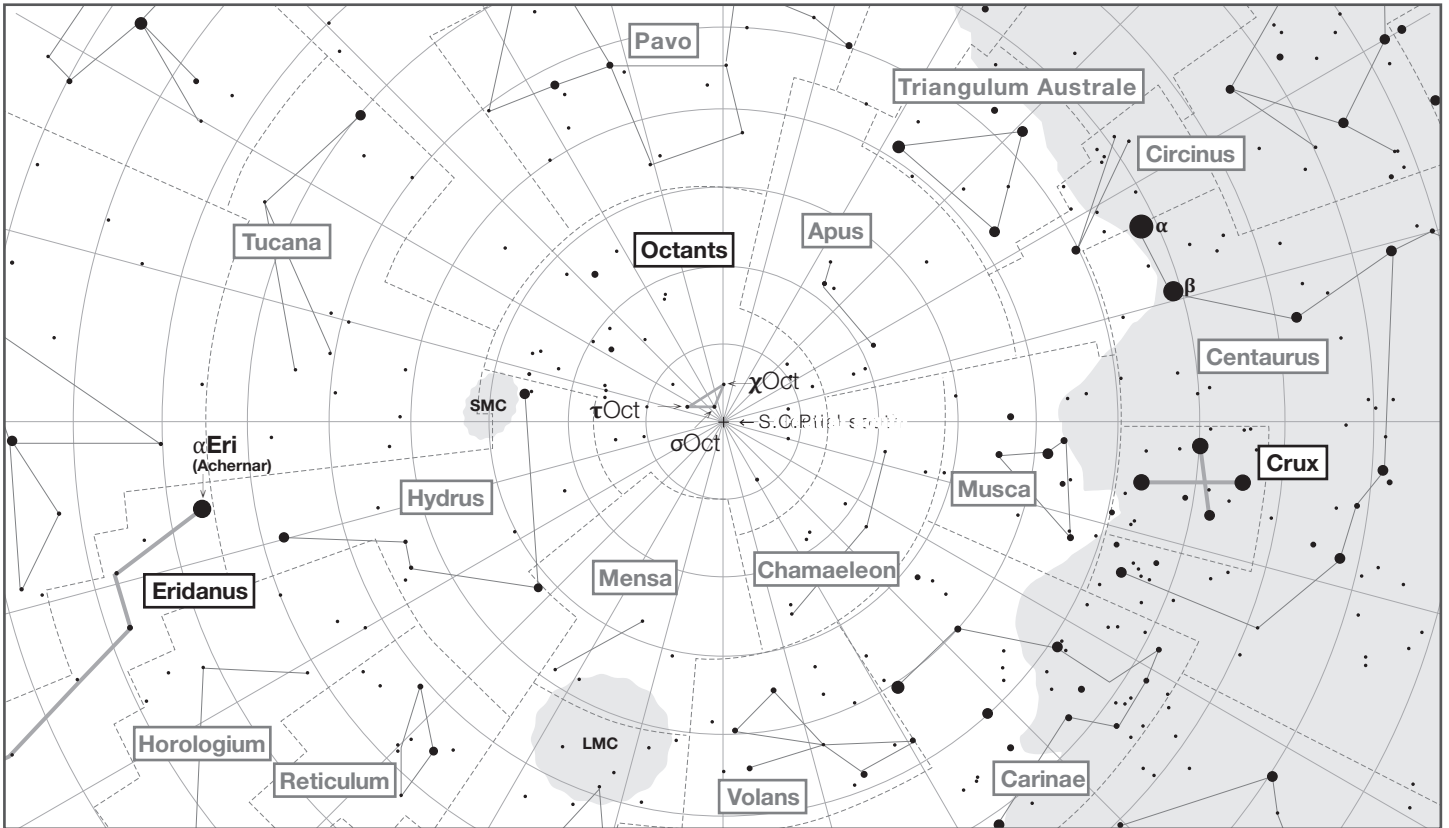

**1** Check your observing site with a compass, a GPS system or a map in advance to confirm that Octans, the Southern Cross and Alpha Eridani can be seen from your observing location on the date of observation.

**2** Set up the mount on flat and hard ground where you can see Octans in the sky. Take off the polar axis cap. Point the polar axis of the mount in the direction of north as shown in the figure. Adjust the tripod legs so that the tripod is as level as possible.

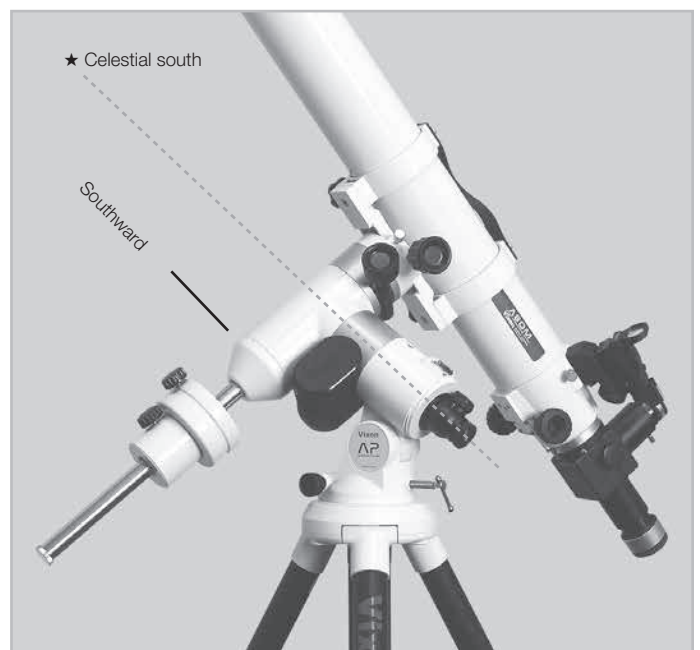
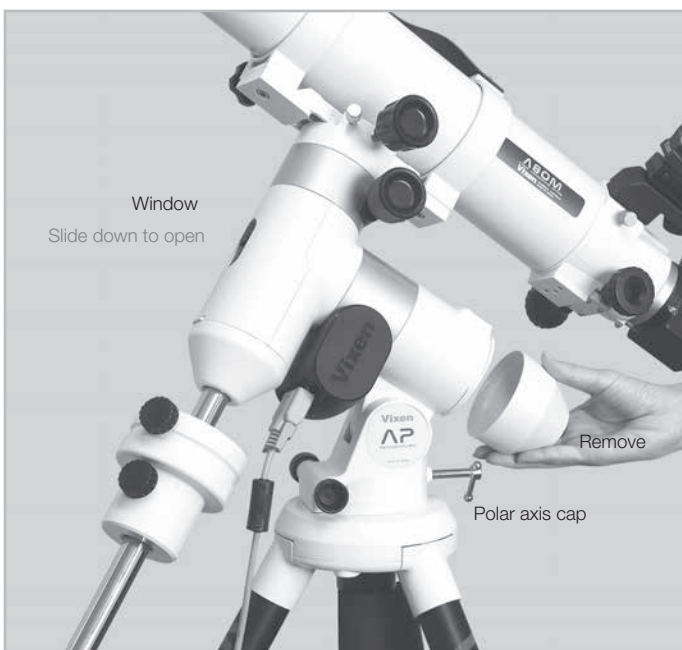

3 Open the round window on the declination body by sliding down the shutter of the window. While looking into the polar alignment scope, turn the polar alignment scope body so that the engraved Southern Cross (or Alpha Eridani) on the reticle directs the Southern Cross (or Alpha Eridani) in the real sky.

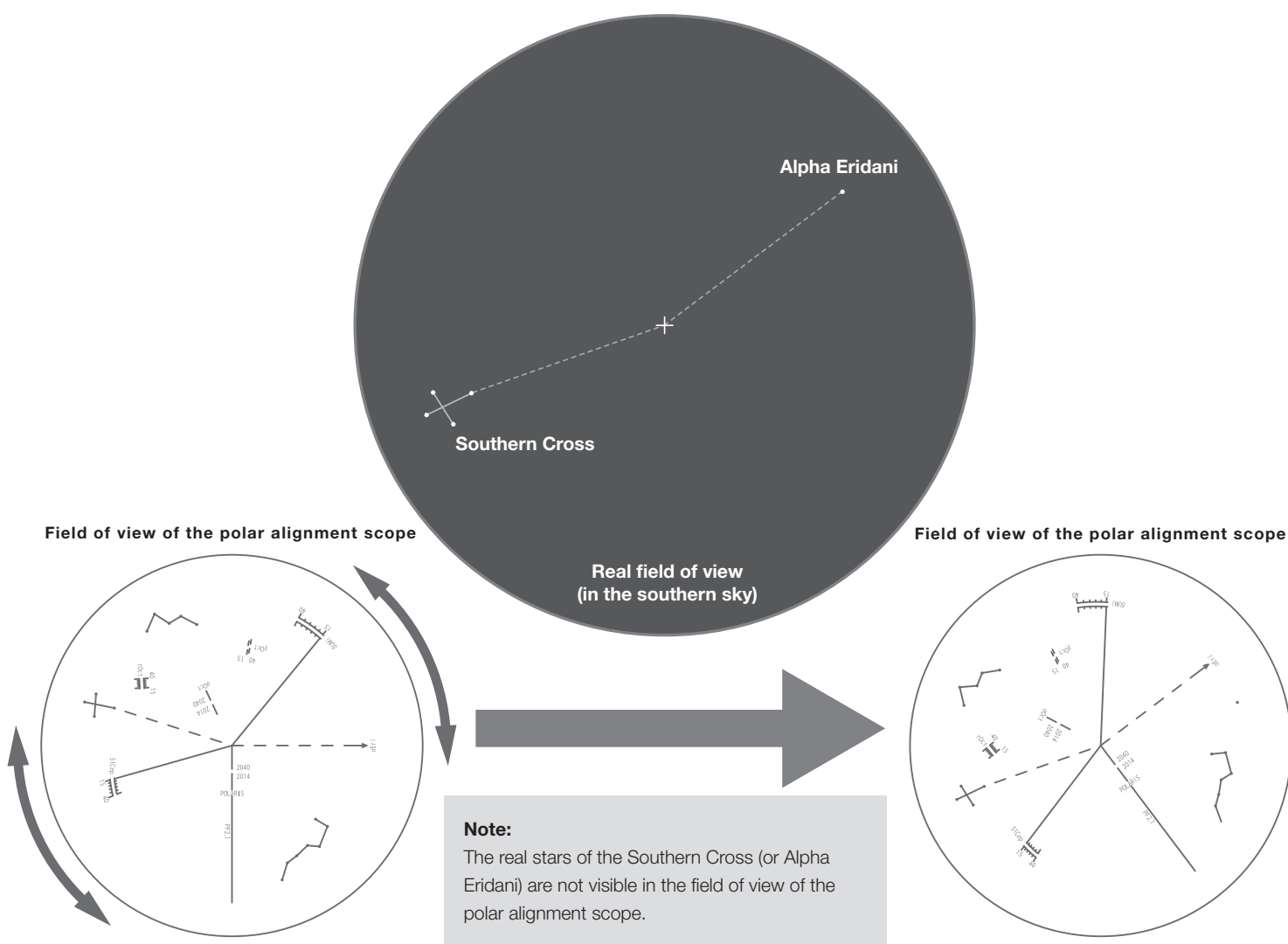
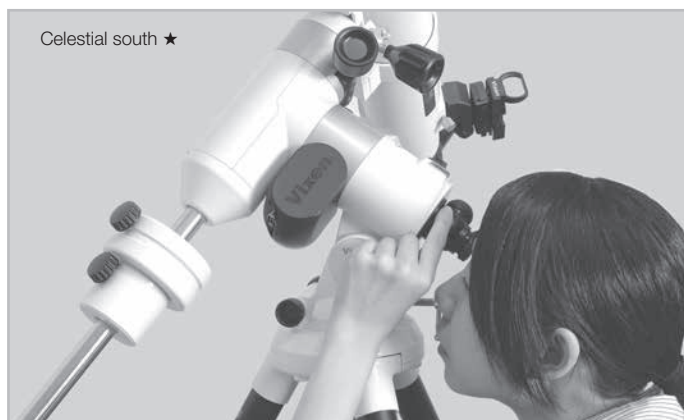

Both the Southern Cross and Alpha Eridani on the reticle are positioned to correspond to the real sky. They are used as a guidepost to know the turning direction of the polar alignment reticle. The locations of the Southern Cross and Alpha Eridani on the reticle have no relation to the locations of the Octantis stars on the reticle.

4 While looking into the eyepiece of the polar alignment scope, adjust the direction of the mount by turning the altitude adjustment bolt and azimuth adjustment knobs so that Sigma Octantis comes as close as possible to the designated position on the reticle.

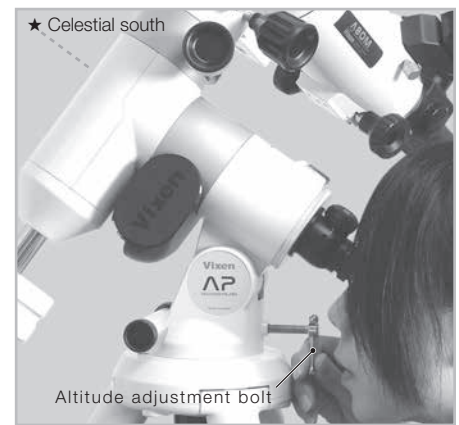
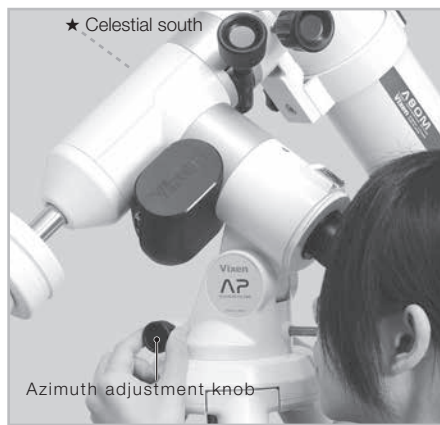

Set Sigma Octantis to the gap between the two segments of the lines marked 2014 and 2040 adjacent to a mark „σ Oct“ as shown in the figure.

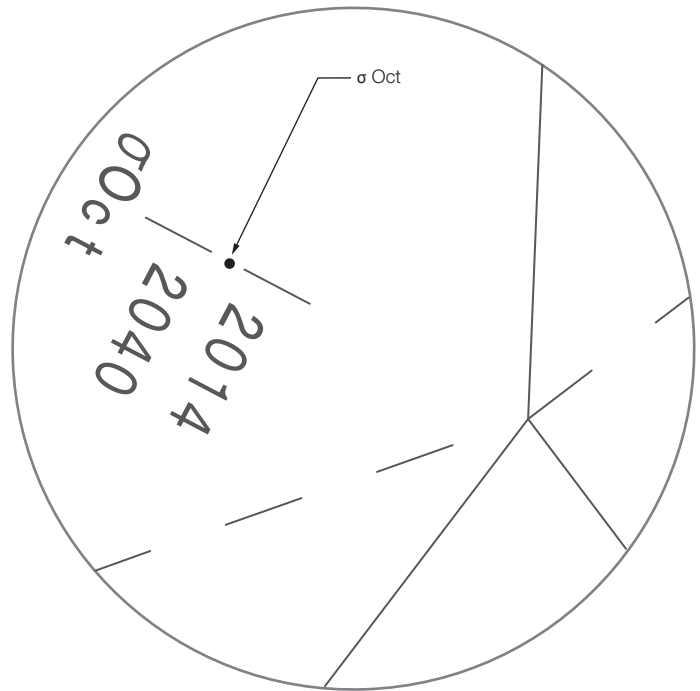

5 As Sigma Octantis shifts to the designated position on the reticle, both Tau Octantis and Chi Octantis come close to their own designated position scales respectively. While looking into the eyepiece of the polar alignment scope, turn the polar alignment scope body so that each of the position scale for Tau Octantis and Chi Octantis come to the closest to actual Tau Octantis and Chi Octantis respectively.

The numbers 15 and 40 on the position scales for Tau Octantis and Chi Octantis show the years 2014 and 2040 respectively.

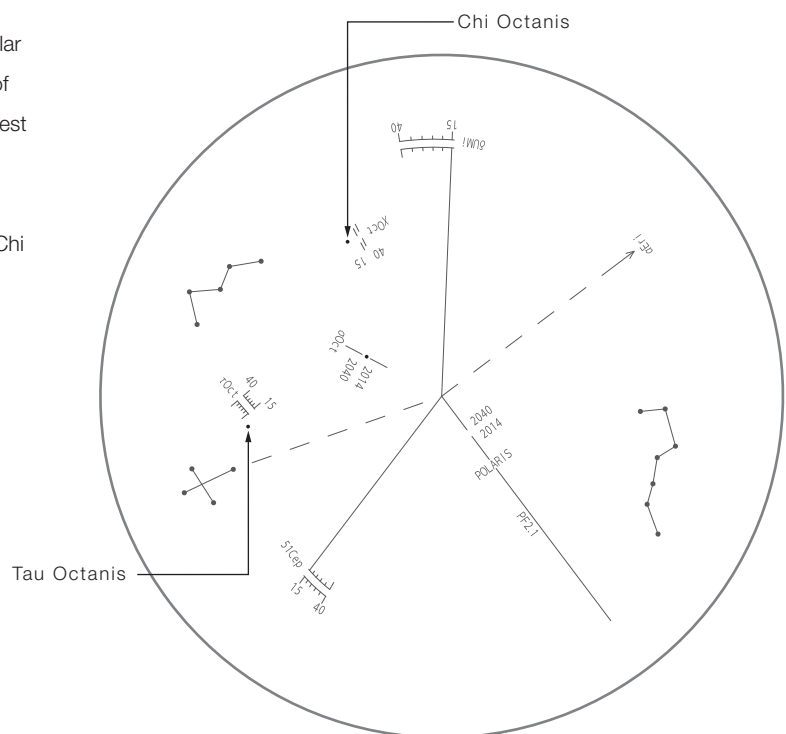

Now, Sigma Octantis gets out of place from the designated position but it is not necessary to correct for it at this stage.

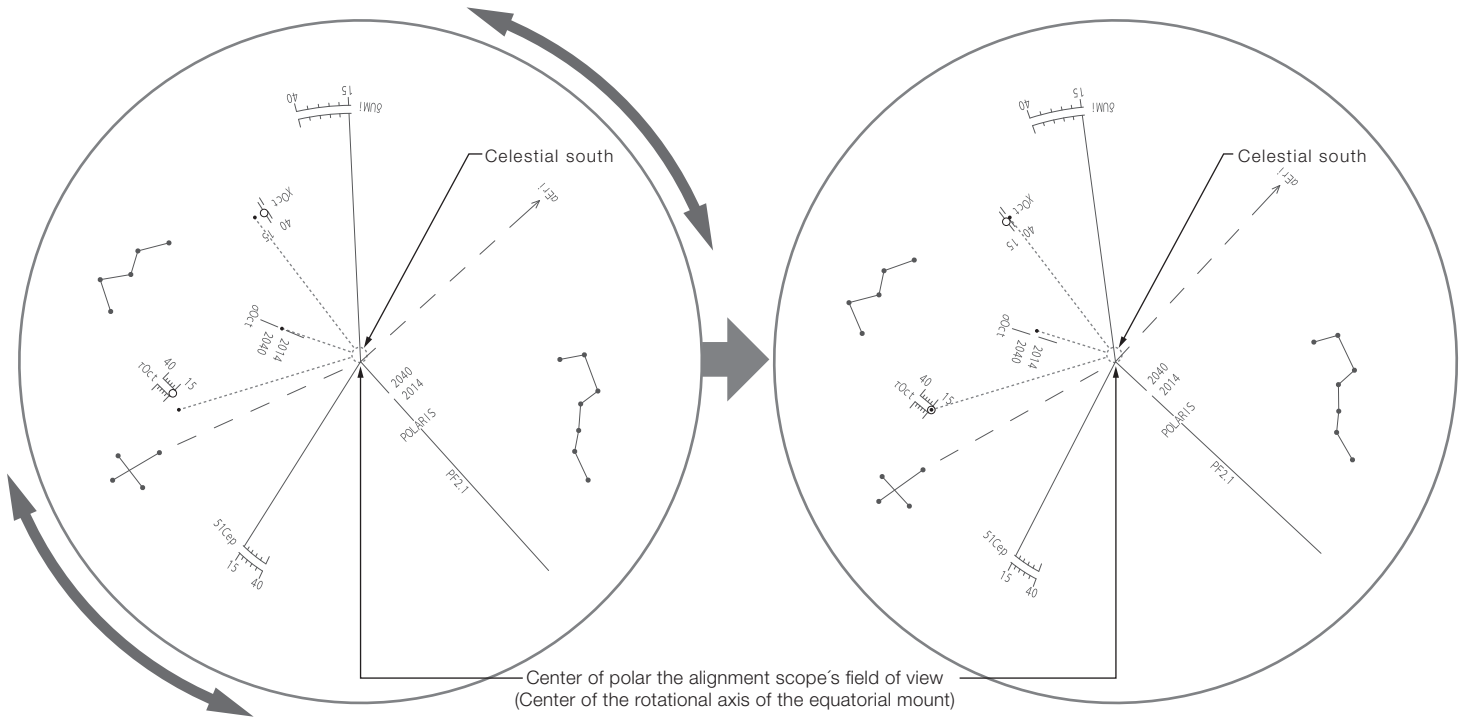

Since there is no mark that points at the South Celestial Pole, you need to match the polar axis of your AXJ mount with the S.C.P. using the inconspicuous three stars of Octans in the same area of the sky.

Your goal is to set Sigma Octantis to the edge of the line on the side of 2014, and both Tau and Chi Octantis are to be set to the middle of the curved lines of the position scale at the protruded edge on the side of 15 respectively. (In case of the year 2014)

Turn the polar scope body so that Tau Octantis comes near to the location of the year 2014 on the scale. And then, Sigma Octantis will get out of position from the gap between the lines.

Adjust the red light illumination to be dimmer if the reticle is too bright to see the 5th magnitude stars Sigma and Tau

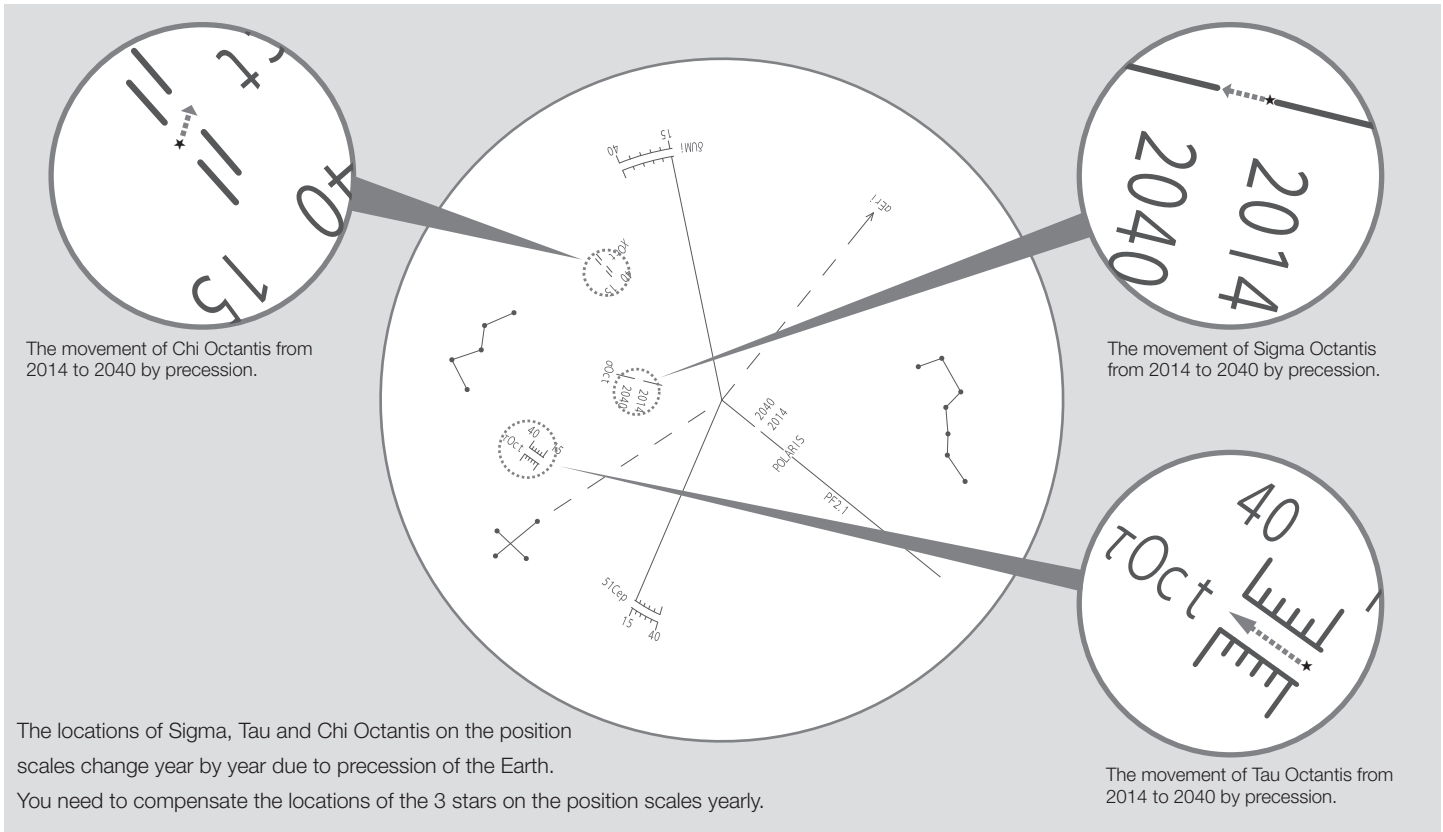

The movement of Chi Octantis from 2014 to 2040 by precession.

The movement of Sigma Octantis from 2014 to 2040 by precession.

The locations of Sigma, Tau and Chi Octantis on the position scales change year by year due to precession of the Earth. You need to compensate the locations of the 3 stars on the position scales yearly.

The movement of Tau Octantis from 2014 to 2040 by precession.

6 While looking into the eyepiece of the polar alignment scope, turn the altitude adjustment bolt and azimuth adjustment knobs so that Sigma Octantis comes to the gap between the two segments of the lines marked 2014 and 2040.

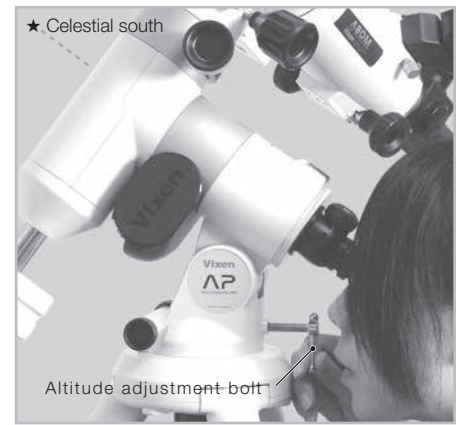

Correcting the position of Sigma Octantis with the altitude adjustment bolt and azimuth adjustment knobs

Correcting the position of Tau and Chi Octantis with a rotation of the polar alignment scope.

Set Sigma Octantis to an approximate position that is corresponding to the year of your observation.

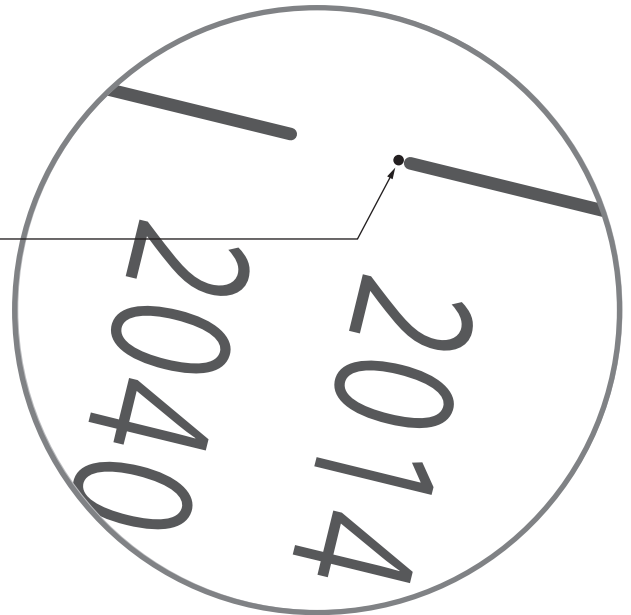

**Note:**

Correcting the position of Sigma Octantis with the altitude adjustment handles and azimuth adjustment knobs.

Correcting the position of Tau and Chi Octantis with a rotation of the polar scope boy

7 Repeat the procedures 5 and 6 until Sigma, Tau and Chi Octantis come to the proper locations on the designated position scales respectively.  
Tighten the azimuth adjustment knobs at both sides to finish the polar alignment.

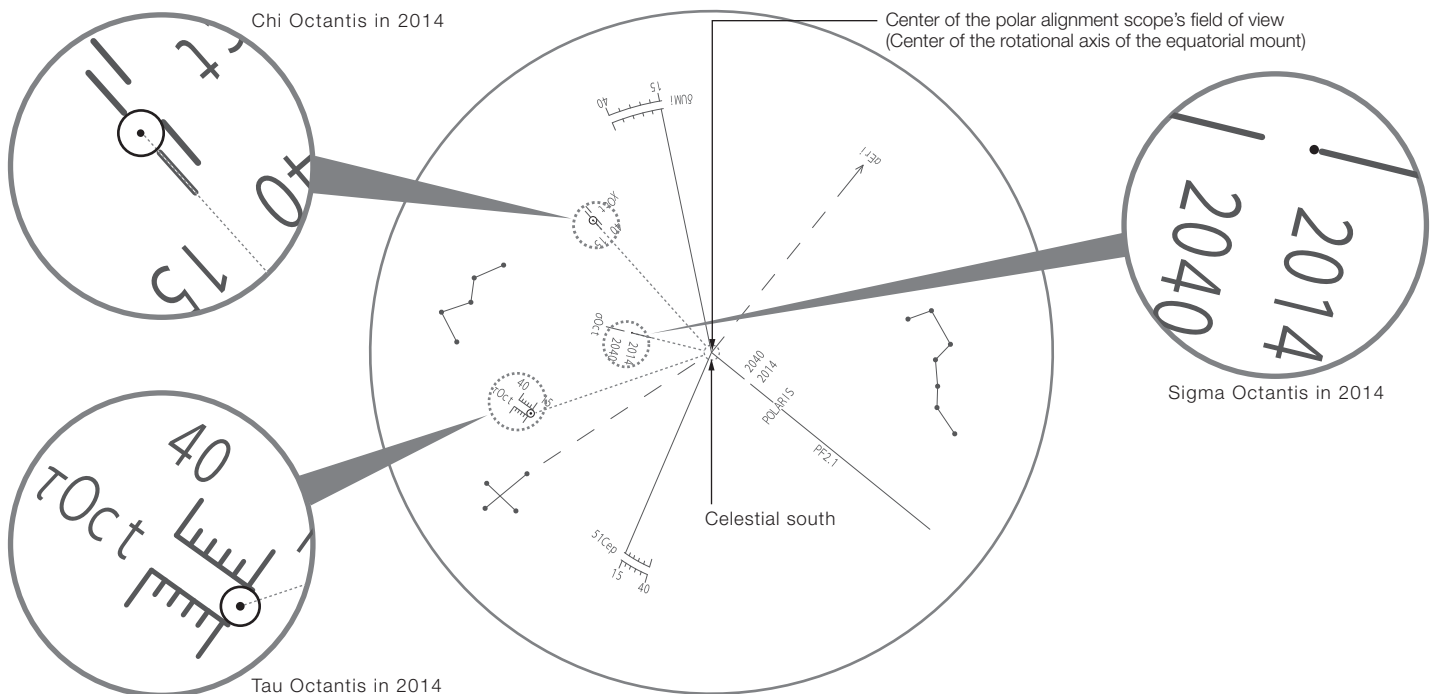

As an illustration here, Sigma Octantis is set to the edge of the line on the side of 2014, and both Tau and Chi Octantis are set to the middle of the curved lines of the position scale at the protruded edge on the side of 15 respectively. (In case of the year 2014)

## Tips on Finding Octans

The constellation Octans is made up of dark stars about 5th magnitude on average. The nearest star to the south celestial pole is Sigma Octantis, which is one of four stars forming a trapezoid in Octans, visible at 5.5th magnitude. There are a few methods to locate inconspicuous Octans using the surrounding stars.

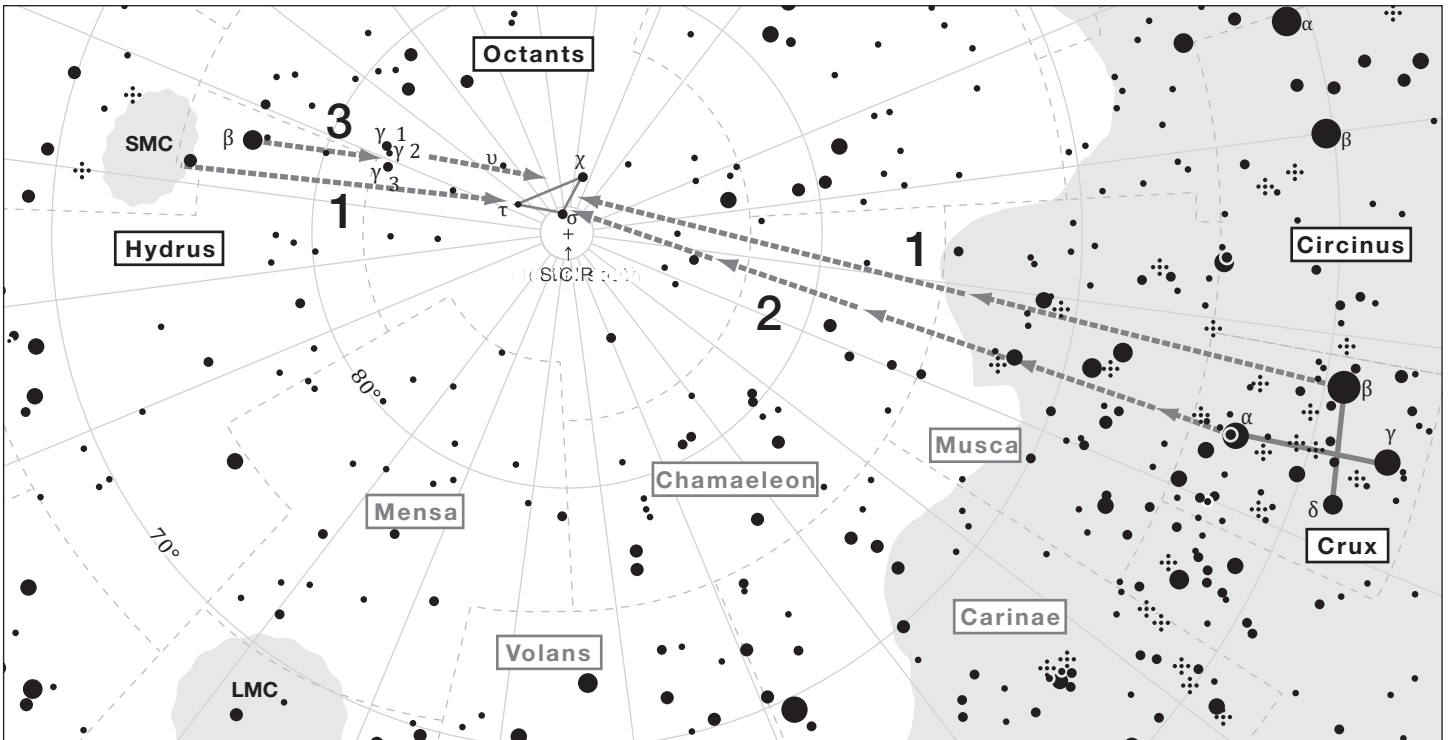

**Note:** The orientation of the Octans changes depending on the season of year.

### 1. Directing to the Octans using Small Magellanic Cloud and the Southern Cross (Crux) as pointers

Draw an imaginary line between the center of Small Magellanic Cloud and Beta Crux and divide it at a ratio of one to two. You will find the four stars of Octans at the divide.

### 2. Directing to the Octans using the arrangement of stars in the Southern Cross (Crux) as pointers

Draw an imaginary line straight through the two stars (Alpha and Beta Crux) of the Southern Cross making the vertical line of the cross toward Small Magellanic Cloud. You will find the four stars of Octans at a place about 4.5 times extended from the span of the two stars.

### 3. Directing the Octans using Small Magellanic Cloud, Beta Hydrus and Gamma Octantis as pointers

If you cast your eyes a little toward Crux from Small Magellanic Cloud, you will see Beta Hydrus. Going southward from Beta Hydrus will find you Gamma Octans which consists of a row of three stars. Continue on your eyes by the same distance toward the Southern Cross and you will find the four stars of Octans.

# Vixen®

---

**Vixen®**

VIXEN - European Distributor: Bresser GmbH | Gutenbergstrasse 2, D-46414 Rhede, Germany  
Phone: +49 (0) 2872 – 80 740      E-Mail: [info@bresser.de](mailto:info@bresser.de) [www.bresser.de](http://www.bresser.de)

Manual\_X000327\_PS-L-II-Polsucher\_en\_Vixen\_122021.indd